



OWNERS MANUAL



Lift MAX

Model Numbers:

LTLMAB, LFLMAB, LQUMAB, LKGMAB, LCKMAB

Head Up, Foot Up, 4-in-1 Legs, Zero Clearance, Two Memory Positions, Massage,
2 USB + Type C, Bluetooth, Underbed Lighting, Foldable Design, and Wireless Remote with Flashlight.

Scan this code to view the most recent assembly and safety instructions or visit: <https://palmetto-sleep.com/manuals>



Safety Precautions and Usage Statements	1
Parts List	4
Installation Guide	5
Remote Guide	7
Phone App Support	9
Headboard Bracket Assembly Instructions	11
Troubleshooting	12
Service Warranty	15

Attention: Important Safety Disclaimers

Read the following information before using this product. Failure to use a surge protector may compromise safety, result in product malfunction, and void the electrical portion of your warranty.

TO REDUCE THE RISK OF SHOCK, BURNS, FIRE OR INJURY

For optimal safety and operation, plug bed base into a surge protector (not included). The bed base should only be plugged directly into a wall outlet or surge protector (strongly recommended). Always unplug the base from the electrical outlet before servicing any part of the base. To reduce risk of electric shock, unplug the base before cleaning. To safely disconnect, ensure the base is in a flat position with all motors off, and unplug from power source. Keep the power cord away from heated surfaces. Never operate the base when the air openings are blocked. Keep air openings free of lint, hair and the like. Do not drop or insert any object into any opening. Discontinue use of the bed base and contact a qualified service center if: it has a damaged cord or plug, if it is not functioning properly or has been dropped into water. Only use this bed base for its intended use as described in this manual. Do not use accessories/attachments that are not recommended by the manufacturer. Close supervision is required when the bed base is used by or near children, convalescents, disabled persons, or pets. Improper connection of the equipment can result in the risk of electrical shock, electrical fire or faulty operation of this bed base. If the plug does not fit your outlet, contact a qualified electrician to install a suitable outlet. Modifying the unit or failing to use a surge protector may void the electrical portion of your warranty.

PETS AND CHILDREN

Immediately dispose of all packing materials as it may pose a smothering risk to small children and pets. To avoid injury, it is not advised to allow children and small pets to play on or under the bed. Children should not operate the bed base without adult supervision.

PACEMAKERS

Some products contain Neodymium magnets which may interfere with devices such as pacemakers, ICD's and any other device sensitive to magnetic fields. It is strongly recommended that owners of such medical devices consult their physician prior to using products that contain Neodymium magnets.

It is also possible that some pacemakers may falsely interpret the optional massage feature vibrations as physical activity or exertion. This is a common occurrence with any product that creates a vibrating movement and may not affect the pacemaker. Please consult your physician before using the massage feature.

IN-HOME USE AND HOSPITAL STANDARDS

Palmetto Sleep Lift adjustable bed bases are designed solely for in-home use. This base is not designed to meet hospital standards or function as a hospital bed. Do not use this base with TENT TYPE oxygen therapy equipment or near explosive gases.

ADDITIONAL SAFETY FEATURES

Casters (optional leg accessory) are equipped with locking wheels to prevent unwanted movement. Even when locked and unable to roll, it is possible for the casters to slide. Free release head and foot motors are designed to lower the mattress by retracting only with gravity, never pulling downwards, which minimizes pinch points.

LIFTING/ LOWERING MECHANISMS

The lift/lower feature will emit a minimal humming sound during operation. This is normal. During operation, the lift arm wheels make contact with the platform support of the base. This may result in metal-on-metal or metal-on-plastic contact. This applies slight tension on the moving components and resonance is reduced to a minimum level. If excessive noise or vibration is experienced, reverse the movement action (up or down) of the base with the remote control. This should realign the base's activating mechanisms to the proper operational position. In normal base operation, the wheels, which allow the bed to maintain its distance from the wall, will make contact with the steel platform supports of the base, which may create audible contact noise. When entering, exiting or shifting weight on the base, this contact noise may be audible as the wheels make contact. This is normal.

MATERIALS

Palmetto Sleep Lift adjustable bases are constructed from various materials including woods, metals, plastics and fabrics. Tension, pressure or movement applied to the frame, platform or shroud through general use may create an audible sound.

MESSAGE OPERATION AND LOCATION ENVIRONMENT

The massage feature will emit a tone during operation. This is normal. As the massage intensity level is increased, the tone will intensify. The volume of this tone is directly related to the location environment. For example, when demonstrated in a show room, the surrounding environmental noise will cover some of the massage noise. However, when installed in a home setting with wooden floors, whether carpeted or not, the massage volume will be more noticeable. To minimize this resonance, place a piece of carpet, or rubber caster cups, under each leg or caster of the base. It is possible to experience vibration or noise from the exterior bed frame, headboard brackets, headboards or footboards if mounting bolts are not firmly tightened.

Levels 1-6 of massage intensity represent the revolutions of the motor per minute. Level 6 provides the maximum number of RPMs. However, this does not mean that the feeling of vibration is the strongest. Depending on the mattress material, thickness, and positioning of user, the feeling of vibrations will differ. Users are encouraged to choose the massage intensity setting that feels most comfortable. Understanding how the massage system behaves at different intensities can help optimize your comfort level. Just as an engine may run rough during idle, as the RPMs increase, the vibrations change concurrently.

TOLERANCE

All Palmetto Sleep Lift adjustable foundations, depending on make and model, are designed and manufactured to perform and function within designated quality control parameters. Bases are subject to meticulous and rigorous inspections during the quality control process to ensure bases will operate within these standards during normal operating use. Normal operating use is defined as the following: Adjustable foundation is to be operated with a mattress and load. Testing procedures require lifetime cycle tests with up to 120kg distributed load.

The angle (designated "A" in figure 1) between the back section and the flat section for various configurations of the mattress support platform shall be $\pm 3^\circ$, which translates to a tolerance of up to 1 1/2".

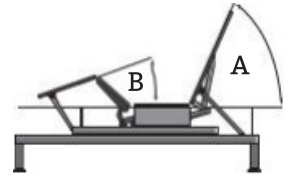

The angle (designated "B" in figure 1) between the flat section and foot

section for various configurations of the mattress support platform shall be $\pm 3^\circ$, which translates to a tolerance of up to 3/4". Any adjustable foundation that meets these parameters is considered to have passed the manufacturer's quality control standards.

THAT "NEW PRODUCT" SMELL

Some people notice a slight odor to their new adjustable base—this can come from our material manufacturing process. This smell is normal and usually disappears before the product reaches you. Sometimes, however, this smell may still be noticeable. It usually disappears after a few weeks, providing adequate ventilation of the product and the environment.

BREAK IN PERIOD

You can speed up the break-in period by spending time in the adjustable bed—such as reading, watching TV, or relaxing with family. These activities help the adjustable base adapt to changes in weight and temperature. Due to material sensitivity, some components may make sounds in colder environments.

PAIRED OPERATION

When operating a "paired" split base setup there may be a time latency up to 1.5 seconds between each base's articulation.

WEAR AND TEAR

Wear and tear refer to damage that occurs naturally and inevitably as a result of normal use or aging.

FABRIC CARE

To prolong the life of your fabric, protect from direct sunlight whenever possible. For spot cleaning, wipe area with a light damp sponge or vacuum with a soft brush attachment to remove particles.

Keep at a minimum of 30 cm (12 inches) away from direct heat sources. For a deeper cleaning, blot liquid spills with a clean dry cloth. Wipe with a clean cloth dampened with warm water. Do not wet excessively. A soft bristle brush may be used to remove ingrained soil. Avoid scratching by gentle brushing. Use a clean, damp cloth to remove any residue. Dry in shade away from direct heat. If persistent marks remain visible after cleaning, seek professional advice.

PRODUCT RATINGS

The lift motors are not designed to operate continuously for more than 2 minutes in an 18-minute period or approximately 10% duty cycle. Attempting to circumvent or exceed this rating will shorten the life expectancy of the product and may void the warranty. The massage motors are not designed to operate continuously for more than 30 minutes at a time. Please allow the massaging system to rest for 30 minutes after automatic massage shut-off before restarting.

WEIGHT LIMITS

This product is not rated to support weights in excess of 750 pounds. The base will structurally support this weight, provided it is evenly distributed across the bed base. The adjustable base is not designed to support or lift this amount in the head or foot sections alone. Exceeding this weight restriction could damage the bed and/or cause injury and will void the warranty.

SAVE THESE INSTRUCTIONS.

FCC Compliance

This device complies with part 15 of the FCC Rules.

Operation is subject to the following two conditions: (1)

This device may not cause harmful interference, and (2) this device must accept any interference received, including interference that may cause undesired operation. To comply with the FCC RF exposure requirements, no change to the antenna or the device is permitted. Any change to the antenna or the device could result in the device exceeding the RF exposure requirement and void the user's authorization to operate the device.

Radio Frequency: 2.4 GHz



Wireless Remote Control (1)



Mattress Retainer Bar (1)



6", 2", 3" & 2"
Adjustable Legs
Can be combined to 13" (6)



Power Supply



Remote Batteries (2)
Power Supply Batteries (2)



Motion Sensor

Setting up your adjustable bed for all sizes.

Step 1

Open the carton in the flat position, bottom facing up to avoid damage. Lay the adjustable base flat on the floor, bottom side up.

Open all the parts boxes and cut the zip ties.

*Be careful not to pinch your fingers or damage any wires located under the frame.



Step 2

Open the accessories box and ensure all accessories are included (see page 1).

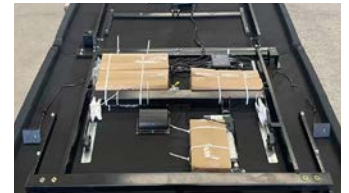

Step 3

To install the six (6) legs, thread the bolt of the leg into the frame and tighten by hand. There are 4 height options: 3", 2", 6" or 13". The 13" height option can be achieved by threading the bolt of the 2" + 3" + 2" into the 6" leg. Then thread the bolt of the legs into the frame.

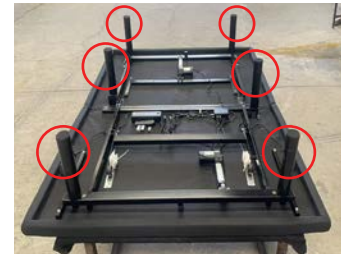

Step 4

Uncoil the input power cord (connected to the control box on the underside of the base) and plug it into the power supply box.



Step 5

With at least two (2) people, flip over the base and insert the mattress bar as shown.



Step 6

To complete assembly, plug the power cord into the wall outlet and use the remote to test the base.



NOTE: For safety reasons, any lifting of the adjustable bed must always be performed by two (2) people. The unit should be on a flat surface before opening.

Step 7

Install the Motion Sensor

Connect the motion sensor cable to the sensor module (already connected to the control box).



Then, use the Velcro strap to attach the motion sensor to the middle leg on each side of the bed, ensuring the sensors face outward.



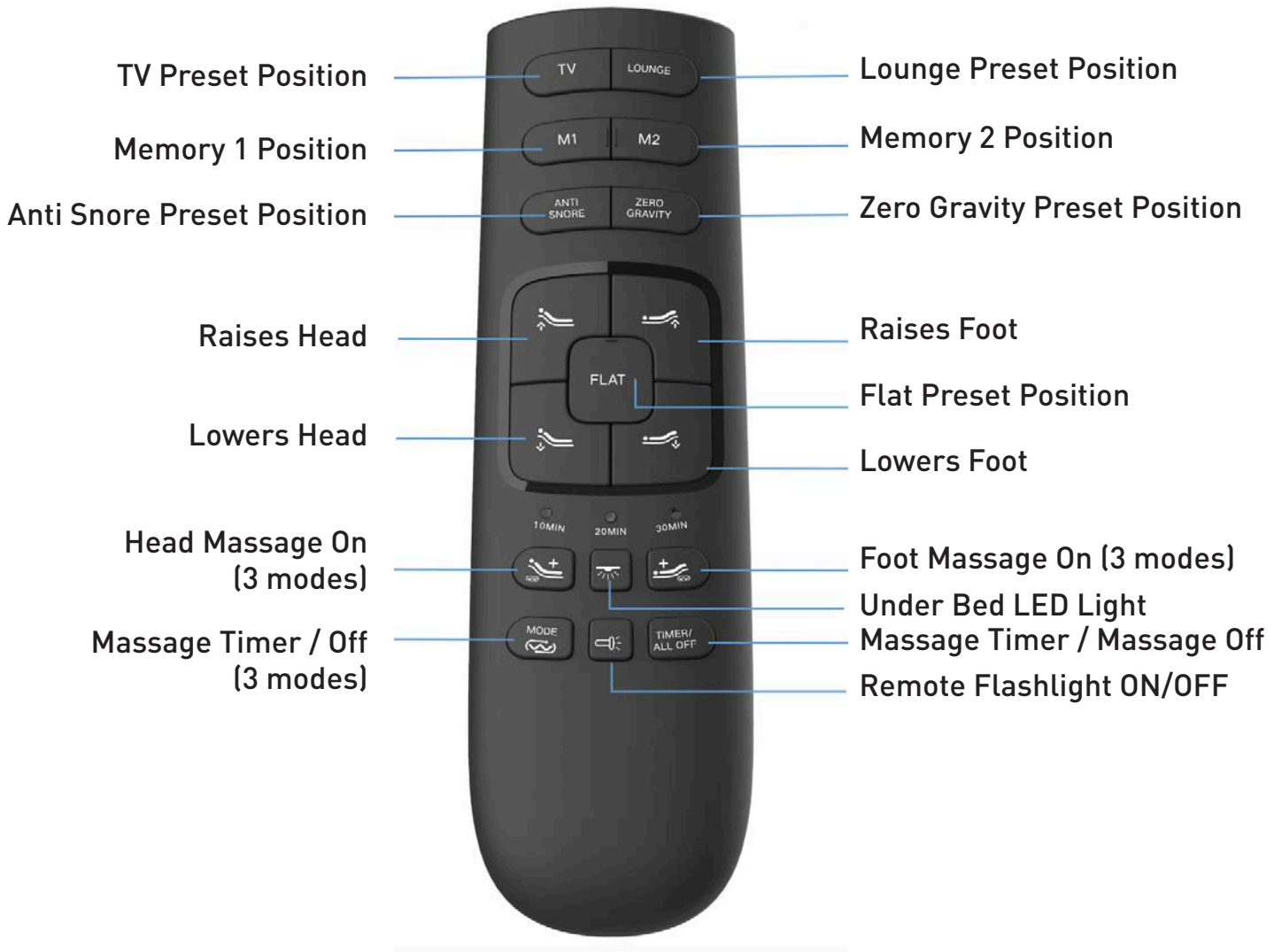

USB ports are located on both sides of the bed. The remote's display light turns red while charging and green when fully charged.

Pairing

Press and hold the pairing button (A) on the power cord. While holding the pairing button, press and hold the Head Lift (B) and Foot Lift button (C) simultaneously on the remote until the device beeps twice. This means the devices have paired successfully. NOTE: The original remote that comes in the box should already be paired to the bed. In the event that the remote is not paired with the bed, follow the steps as listed above and in the below diagram. Pairing is needed for wireless remotes only.

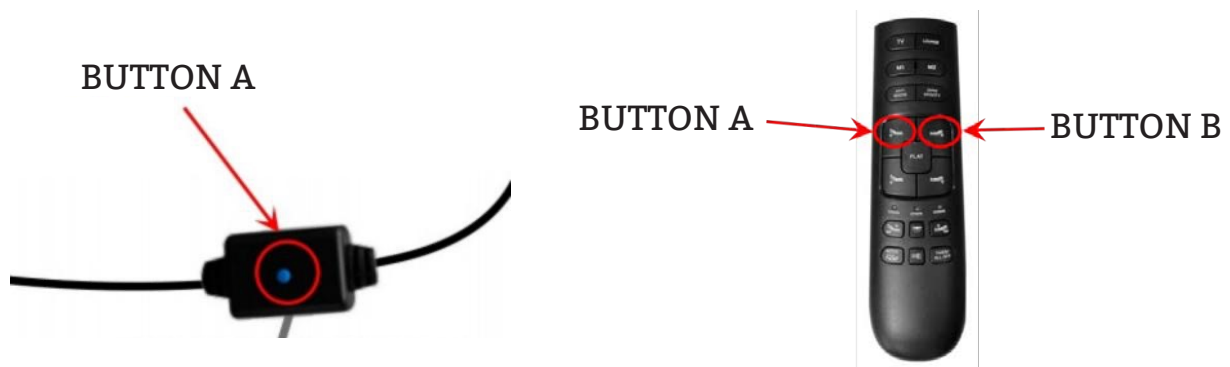

Button A: Pairing Button located on the power cord

Button B: Head Lift button & **Button C:** Foot Lift button located on the remote

Setting Programmable Memory or Preset Positions

Your new adjustable base has a programmable feature that allows you to set and save custom positions. Please read the instructions below before setting your custom presets on the remote.

Step 1: Adjust the head and foot to your desired position.

Step 2: Press and hold the M1 or M2 button - whichever button you would like to set. Hold the Memory button for five seconds until the base beeps 3 times. The position is then saved.

Step 3: To adjust the saved position, repeat steps 1 and 2 to save a new position.

To operate two adjustable beds simultaneously, you must pair both beds (Bed A & Bed B) to one remote control (Remote A) using the pairing instructions listed above. Before pairing, make sure that both beds are in the Flat Position. To control the beds separately again, pair the second remote to either base using the pairing instructions listed above.

How to Cancel Synchronization Between Two Beds

Use Remote B to pair Bed B using the pairing instructions listed above, and then the Remote A won't be able to control both beds anymore.

Bluetooth and Mobile App

How to Download and Configure

Step 1

If you are an iPhone user, please download this from the Apple App Store: "RM CONTROL"

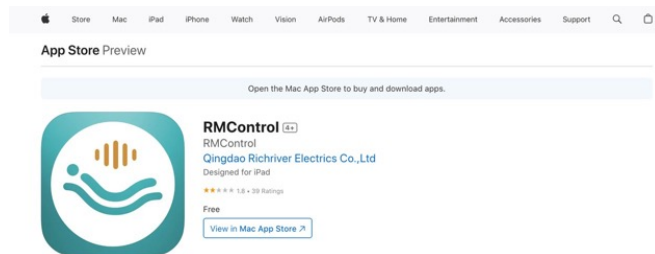

If you are an Android user, Please download this from the Google store: "RM CONTROL"



Step 2

Launch the app and select the device ID labeled 'QR-RMXXXXXX' (10 characters)



Step 3

Next, scan the QR code sticker on the back of your remote.

Step 4

After scanning the QR code, you'll be redirected to the configuration page. Enter 'XJRM', press 'Search', and the control interface will appear. You can now control the motor via the app.

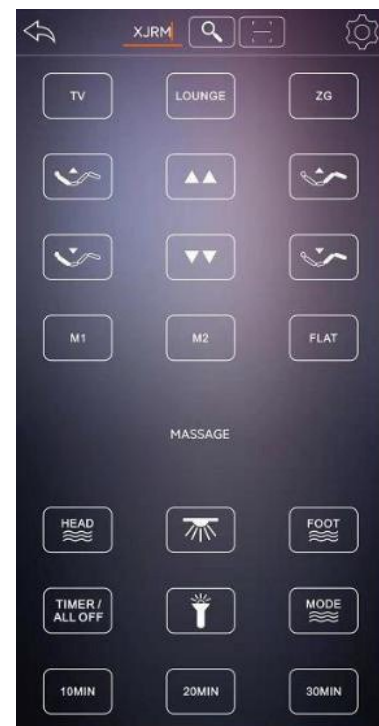

For toll-free customer service, call +888-313-0758 or Email us: palmetto_sleep@serveco.com.

Please be prepared to tell us your name, phone, address and product serial number (can be found on the back of the remote).

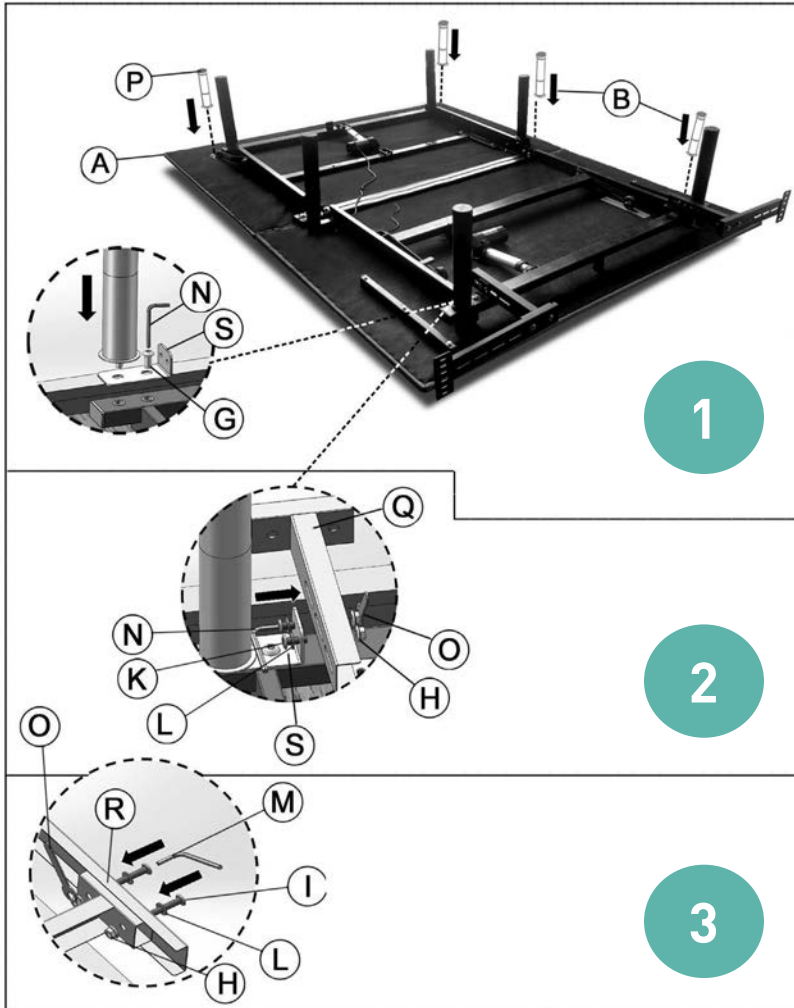
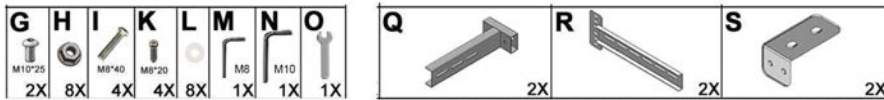

STEP 1

Fix the connector with the leg **(B)** and the screw **(G) (M10*25)**, as shown in the image. Use the allen key M10 **(N)**.

STEP 2

Fix the Metal Bracket-A **(P)** with 2* MB*20 screws **(K)**, 2*nut **(H)** and 2* washer **(L)**, as shown in the image. Use the allen key MB **(M)** and Spanner **(O)**.

STEP 3

Fix the Metal Bracket-B **(Q)** with 2*MB*40 **(I)** screws, 2*nut **(H)** and 2*washer **(L)**, as shown in the image. Use the allen key **MB (M)** and Spanner **(O)**.

Note: HBB is a option not necessary.

Customer Service & Warranty

For toll-free customer service, call or Email us:
Please be prepared to tell us your name, phone, address and product serial number (can be found on the back of the remote).

Your new base is covered under a full 1 year warranty and 5 year limited warranty. For details on the warranty or to view a PDF of this manual, please scan the QR code above or on the back of the remote.

Remote control illuminates and appears to be operable, but will not activate bed.

Verify that the power cord is plugged into a working, grounded electrical outlet. Test the outlet by plugging in another working appliance.

Program the remote control (see 'Setting Programmable Positions and Pairing Remote' section for instructions).

No features of the power foundation will activate.

Unplug the power cord, wait 30 seconds and plug it back in to reset the components.

The surge protection device or the electrical outlet may be defective. Test the outlet by plugging in another working appliance.

Verify that the connector on the wired remote control is securely attached to the control box.

Wireless remote will not illuminate.

Replace the batteries in the wireless remote.

Head or foot section will elevate, but will not return to the horizontal (flat) position.

Bed mechanism may be obstructed. Elevate bed and check for obstruction. Remove obstruction.

Head section may be too close to the wall.

Headboard may be too close to the edge of the mattress. Verify that there is enough distance between the headboard brackets and mattress. Adjust if required.

A clicking noise is heard under the bed when raising or lowering.

This is normal. The lift motor relays "click" when they are engaged. No action is required.

Massage motor overheats or stops.

If the vibration motor overheats, the thermal protection will turn the motor off. Wait 30 minutes, turn the massage back on. If it does not come on, turn it off and report the situation to customer service.

Head & Foot lift function has minor interference during operation.

Check batteries in wireless remote control, replace with two(2) new AAA batteries if necessary.

Make sure that you are following the duty cycle of the motors(do not operate more than two minutes over a 18-minute period, or approximately 10% duty cycle).

Press the lift buttons firmly and accurately.

Wireless remote control may be experiencing common Radio Frequency Interference from other radio transmitting devices. Wait several seconds, and then try pressing the button again. See FCC Compliance Statement below.

FCC COMPLIANCE:

This device complies with part 15 of the FCC Rules for residential use. Operation is subject to the following two conditions: (1)This device may not cause harmful interference, and (2) this device must accept any interference received, including interference that may cause undesired operation.

Radio Frequency: 2.4 GHz.

Excessive massage motor noise.

If the bed is located on hard surface flooring, place carpet pieces or rubber pieces (not included) under each leg.

Using the wireless remote control, elevate the head, foot or neck section a short distance to realign the lift/lower mechanisms with the bed support platform.

Verify that your Power Foundation is not positioned against a wall, nightstand, or other object that may cause the vibration or noise.

If the Power Foundation is installed over a bed frame, verify that the massage motors are not causing the bed frame (or bed frame components) to vibrate.

Verify that the headboard attachment hardware is properly tightened (if used).

Palmetto Sleep Lift Max Ten Year Limited Warranty

Palmetto Sleep warrants to the original consumer purchaser that the motorized adjustable bed foundation, adjustable bed frame or adjustable bed (hereinafter referred to as “adjustable bed” or “adjustable beds”) are free from defects in workmanship and material as provided herein. This Limited Warranty is not transferable, and coverage terminates if the original consumer purchaser (“purchaser”) sells or otherwise transfers the product.

If you wish to make a claim

You must contact the Palmetto Sleep dealer from whom the product was purchased, or if not available, 888-313-0758, or palmetto_sleep@serveco.com within thirty days of discovery of the problem with the serial number and the original sale receipt which identifies the date of purchase. Any information or materials to be returned upon authorization should be sent to Palmetto Sleep at 418 Chandler Dr., Gaffney, SC 29340.

What we will do

Year 1: Full coverage parts and labor warranty This adjustable bed is warranted against defects in the workmanship or materials for a period of up to one (1) year from the date of purchase for adjustable beds bought new and for up to one (1) year from the date of manufacture for those beds that were originally floor samples. Palmetto Sleep will send replacement parts (at no cost to the purchaser) for any defective or malfunctioning adjustable bed part to the purchaser, and Palmetto Sleep will pay all pre-authorized labor and transportation costs associated with the repair or replacement of any parts which Palmetto Sleep determines to be defective or malfunctioning. This warranty does not apply unless all defective parts are returned within 15 days.

Years 2 and 3: Full coverage of parts only warranty If the defect occurs in the second or third year following purchase for adjustable beds bought new and following the date of manufacture for adjustable beds that were originally floor samples, Palmetto Sleep will offer replacement parts (upon terms and conditions set forth in this paragraph) for any mechanical bed part found to be defective or malfunctioning. This limited warranty shall not apply if purchaser does not return any and all defective or malfunctioning parts to Palmetto Sleep within 15 days of purchaser’s receipt of replacement parts. The purchaser shall bear all service, transportation, labor, shipping and handling costs related to the delivery and/or replacement of the defective or malfunctioning parts.

Years 4 through 10: Prorated coverage of non-electrical parts only warranty If the defect occurs in the fourth through twentieth year following purchase for adjustable beds bought new and following the date of manufacture for adjustable beds that were originally floor samples, Palmetto Sleep will offer replacement parts (upon terms and conditions set forth below) for any mechanical bed part found to be defective or malfunctioning. Electronics, electrical components, massage motors and lift motors are excluded. The purchaser shall pay 1/17th of the then-current cost of the defective part for each year past the third. Palmetto Sleep will cover the remainder. This limited warranty shall not apply if purchaser does not return any and all defective parts to Palmetto Sleep within 15 days of purchaser’s receipt of replacement parts. In those situations where this limited warranty applies, the purchaser shall bear all service, transportation, labor, shipping and handling costs related to the delivery and/or replacement of the defective or malfunctioning parts.

This limited warranty does not cover or apply

This Limited Warranty does not apply: (a) to any damage caused to the adjustable bed by the purchaser; (b) if there has been any unauthorized repair or replacement of the adjustable bed or parts; (c) if the adjustable bed has been mishandled whether in transit or by other means, subjected to physical or electrical abuse or misuse, or otherwise operated in any way inconsistent with the operation and maintenance procedures outlined in the Owner's Manual, this limited warranty, and any other applicable document published or approved by Palmetto Sleep; (d) in relation to damage to mattresses, fabric, cables, electrical cords or items supplied by dealers (also known as retailers or resellers); (e) if there has been any unnecessary service calls, including costs for in-home service calls solely to educate the purchaser about bed features or connections. (f) if the recommended weight restrictions (Twin/TXL/Split QN/Split CA King: 400 pounds, Full/FXL: 500 Pounds, Queen: 600 Pounds) and guidelines for proper distribution of weight as stated in the Owner's Manual are not followed; (g) for adjustable beds used in commercial type settings, such as but not limited to dormitories, hotels and rentals.

Additional terms and conditions

No reimbursement will be made to the purchaser for the inconvenience, removal, installation, setup time, lack of use, shipping, or any other costs or expenses not covered by this limited warranty. Palmetto Sleep holds no responsibility for in-home service on adjustable beds. Purchaser should contact his dealer for any terms and conditions relating to purchaser's in-home service if any.

THIS LIMITED WARRANTY REPLACES ALL OTHER WARRANTIES EXPRESSED OR IMPLIED INCLUDING THE IMPLIED WARRANTIES OF MERCHANTABILITY AND FITNESS FOR PURPOSE AND NO ONE IS AUTHORIZED TO ASSUME OR UNDERTAKE FOR PALMETTO SLEEP OTHER LIABILITY IN CONNECTION WITH THE SALE OF THE PRODUCT. PALMETTO SLEEP SHALL NOT BE LIABLE FOR ANY CONSEQUENTIAL OR INDIRECT DAMAGE OF WHATEVER KIND, INCLUDING PERSONAL INJURIES OR DAMAGE TO PROPERTY, EXCEPT AS PROVIDED HEREIN.

This warranty is made by Palmetto Sleep and is not made by or on behalf of its distributors, retailers or any other party. Some states do not allow the exclusion or limitation of incidental or consequential damages or the exclusion of implied warranties or the limitation on how long an implied warranty lasts, so the above limitations or exclusions may not apply to you. This warranty gives you specific legal rights, and you may also have other rights which vary from state to state.